

Model: CLS-BLLF240W



LED Floodlights 240W

Model: CLS-BLLF240W

Power: 240 watt
LED type: Bridgelux
Efficiency: 160lm/w
Driver: Meanwell
Input voltage: 90-305VAC
CCT: 2800-7500K
Beam angle: 10,25,40,60,90 degree
Housing: 6063 Aluminum
Lens: PC material
Dimension: 490*465*260mm
Weight: 8.9kg
Operating Temperature -40-+60°C
Lifespan: >80,000 hours
Warranty: 5years
Certification: TUV SAA ETL DLC CE RoHS
Testing report: IP66 IK10 IES LM79 LM80

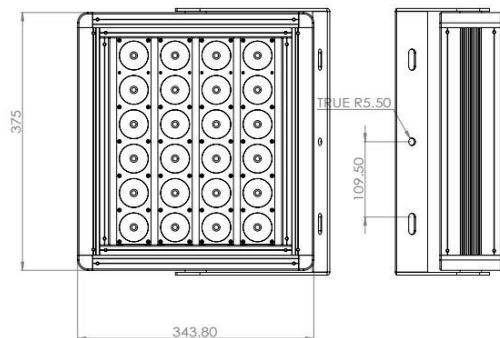
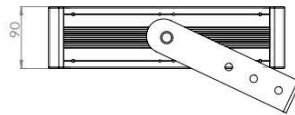

Model: CLS-BLLF300W



LED Floodlights 300W

Model: CLS-BLLF300W

- Power: 300 watt
- LED type: Bridgelux
- Efficiency: 160lm/w
- Driver: Meanwell
- Input voltage: 90-305VAC
- CCT: 2800-7500K
- Beam angle: 10,25,40,60,90 degree
- Housing: 6063 Aluminum
- Lens: PC material
- Dimension: 404*375*90mm
- Weight: 12kg
- Operating Temperature -40-+60°C
- Lifespan: >80,000 hours
- Warranty: 5years
- Certification: TUV SAA ETL DLC CE RoHS
- Testing report: IP66 IK10 IES LM79 LM80

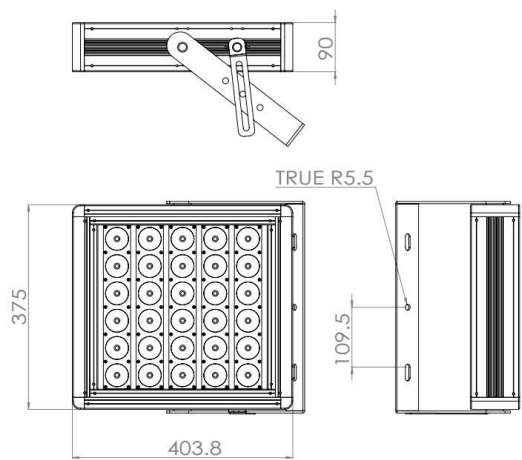

Model: CLS-BLLF360W



LED Floodlights 360W

Model: CLS-BLLF360W

Power: 360 watt
LED type: Bridgelux
Efficiency: 160lm/w
Driver: Meanwell
Input voltage: 90-305VAC
CCT: 2800-7500K
Beam angle: 10,25,40,60,90 degree
Housing: 6063 Aluminum
Lens: PC material
Dimension: 600*560*270mm
Weight: 15.3kg
Operating Temperature -40-+60°C
Lifespan: >80,000 hours
Warranty: 5years
Certification: TUV SAA ETL DLC CE RoHS
Testing report: IP66 IK10 IES LM79 LM80

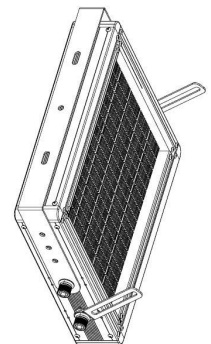
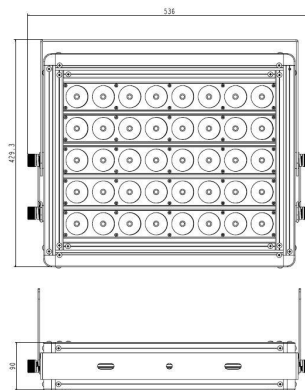

Model: CLS-BLLF400W



LED Floodlights **400W**

Model: CLS-BLLF400W

Power: 400 watt
LED type: Bridgelux
Efficiency: 160lm/w
Driver: Meanwell
Input voltage: 90-305VAC
CCT: 2800-7500K
Beam angle: 10,25,40,60,90 degree
Housing: 6063 Aluminum
Lens: PC material
Dimension: 536*429*90mm
Weight: 16kg
Operating Temperature -40-+60°C
Lifespan: >80,000 hours
Warranty: 5years
Certification: TUV SAA ETL DLC CE RoHS
Testing report: IP66 IK10 IES LM79 LM80

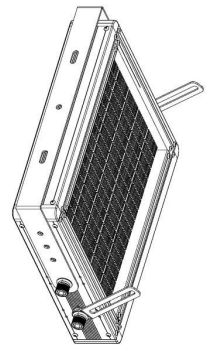
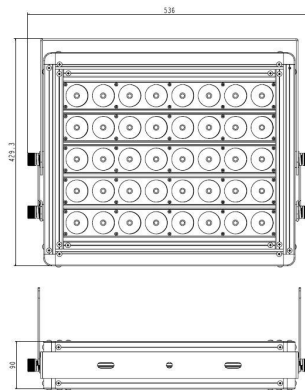

Model: CLS-BLLF500W



LED Floodlights **500W**

Model: CLS-BLLF500W

Power: 500 watt
LED type: Bridgelux
Efficiency: 160lm/w
Driver: Meanwell
Input voltage: 90-305VAC
CCT: 2800-7500K
Beam angle: 10,25,40,60,90 degree
Housing: 6063 Aluminum
Lens: PC material
Dimension: 536*507*90mm
Weight: 16.5kg
Operating Temperature -40-+60°C
Lifespan: >80,000 hours
Warranty: 5years
Certification: TUV SAA ETL DLC CE RoHS
Testing report: IP66 IK10 IES LM79 LM80

